

Digital TS Re-multiplexer

DCH-6000MX

User Manual

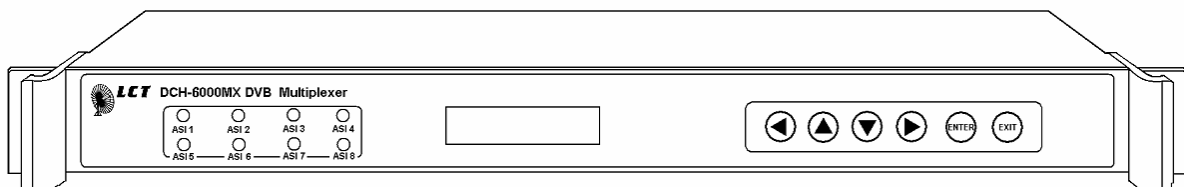







Contents

- Warnings and Notices 3
- 1 Overview 4
 - 1.1 General 4
 - 1.2 Features 4
 - 1.3 Panels and Interface 4
 - 1.3.1 Front Panel 4
 - 1.3.2 Rear Panel 5
- 2 Specifications 5
- 3 Typical Application 6
- 4 Menu Structure and Operation 7
 - 4.1 Menu Tree 7
 - 4.2 Menu Operation 8
 - 4.2.1 Initialization 8
 - 4.2.2 Inputs Setup Menu 8
 - 4.2.3 Outputs Setup Menu 9
 - 4.2.4 Mux Menu 10
 - 4.2.5 System Menu 11
- 5 Installation and Initial use 13
- 6 Accessories 15

Warnings and Notices

- Please follow the below instructions. Don't connect power before you finish installing and checking according to safe procedure.

 <p>Electrical Shock</p> <p>Thoroughly check your electrical grounding and connectors prior to powering. Make sure all connectors are of the three-prong type to ensure proper grounding.</p> <p>Whenever the equipment is not used for a prolong period of time, you should disconnect the power cord.</p>	 <p>Avoid Moisture</p> <p>Do not use this equipment in high moisture environment</p> <hr/>  <p>No Heavy Stacking</p> <p>Do not stack the equipment back to back to allow proper ventilation</p> <hr/>  <p>No Touching with Bare Hands</p> <p>Do not touch the equipment during heavy lightning condition.</p> <hr/>  <p>Caution</p> <p>1.Do not place this equipment on unstable support. 2.Do not place objects on top of the equipment to block up the ventilation opening. 3.Do not place radioactive instrument or object on top of adjacent to the equipment. 4.Provide proper room ventilation during operation of this equipment. 5.Verify with the repair engineer or authorized entity after repair is done to be sure the equipment can be put back to operation. 6.Read the operating manual prior to usage.</p> <hr/>
 <p>Power Disconnect</p> <p>Disconnect the power cord under the following conditions</p> <ol style="list-style-type: none"> 1.damage on cord and connector 2.equipment get wet or substantial moisture enter the chassis 3. Exposure to rain or water 4. equipment dropped or damaged 5.Apparent irregularity appears 	
 <p>Don't Open The Equipment</p> <ol style="list-style-type: none"> 1. Do not try to repair by yourself. 2. Do not use unauthorized part for repair. 3. Do not open the covers of the equipment without proper factory authorization. 	

DCH-6000MX TS Re-multiplexer

1 Overview

1.1 General

DCH-6000MX is a compact and cost-effective DVB MPEG-2 TS re-multiplexer which can multiplex up to 8 ASI transport streams and deliver with 2 ASI ports (1 for redundancy). The combination of PID-packet-exchanging based technology; Ethernet remote control and 19" rack mountable chassis make it an ideal device for a wide range of re-multiplexing applications including cable and terrestrial regional head-ends.

1.2 Features

- Fully compliant with DVB ETSI 300421 standard
- Processing of up to 8 SPTS or MPTS
- SI/PSI automatic regeneration
- Service and PID packet filtering and re-multiplexing
- Up to 160Mbps Mbps MPTS/ SPTS inputs
- Output rate up to 100 Mbps
- ASI input packet length 188/204 bytes Self-adapting. Output packet length 188/204 bytes optional.
- 8 ASI inputs, 2 ASI outputs (1 for redundancy)
- Standard 19" rack 1U chassis installation
- Network remote control and software upgrade

1.3 Panels and Interface

1.3.1 Front Panel

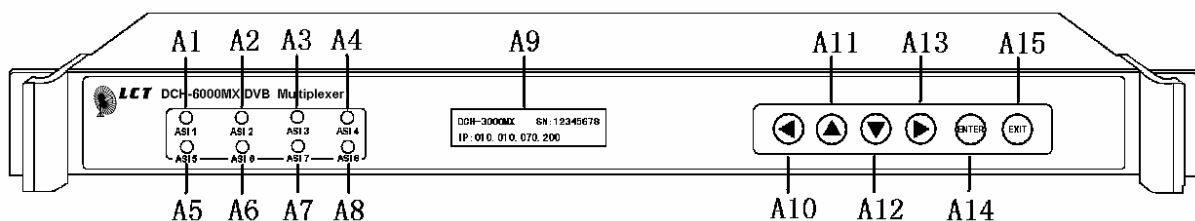

- A1A8 Indicators for ASI 1-ASI 8 Input Status, respectively
- A9 2 × 24 character LCD Menu Display
- A10-A13 Arrow buttons for menu navigating and parameters modifications
- A14 □Enter□ button for issuing a command or selecting an option
- A15 □Exit□ button for returning to previous menu

1.3.2 Rear Panel

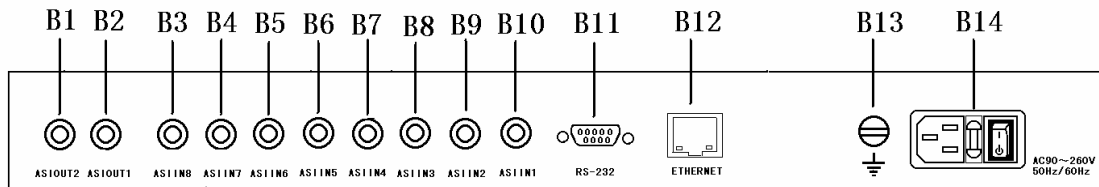

B1	ASI OUT 2
B2	ASI OUT 1
B3-B10	ASI IN 8- ASI IN 1
B11	RS-232 port for debug
B12	Ethernet port
B13	Grounding Terminal
B14	Power cord socket 90V~260ACV, 50Hz/60Hz

2 Specifications

ASI input	
ASI Input Connector	BNC female 75 Ω
ASI Input bit rate	Up to 160Mbps
Data format	Byte, Burst (self-adapting)
Packet length	188/204 bytes (self-adapting)
ASI output	
ASI Output Connector	2 ASI Output (1 for redundancy), BNC connector, 75 Ω
ASI Output bit rate	\leq 100Mbps
Date transfer mode	Byte
Packet length	188/204 bytes (selectable)
Signal level	800mV \pm 10%
Other	
Net weight	3Kg
Size	44mm \times 240mm \times 430mm
Running temperature	0~40
Deposit temperature	-20~70
Humidity	85%

3 Typical Application

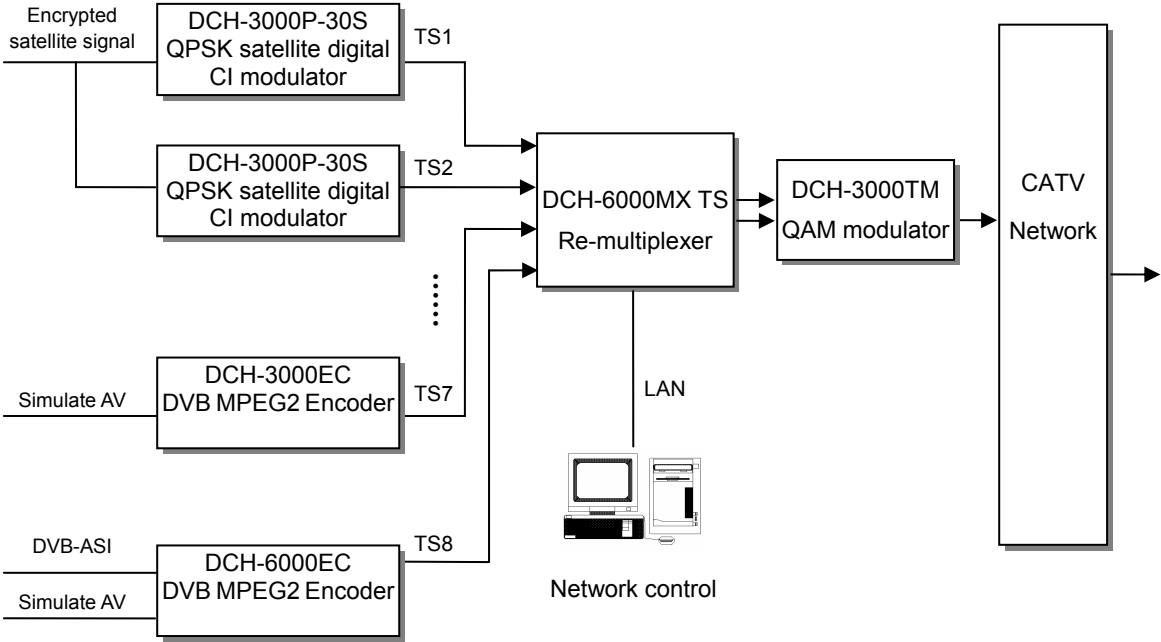

4 Menu Structure and Operation

4.1 Menu Tree

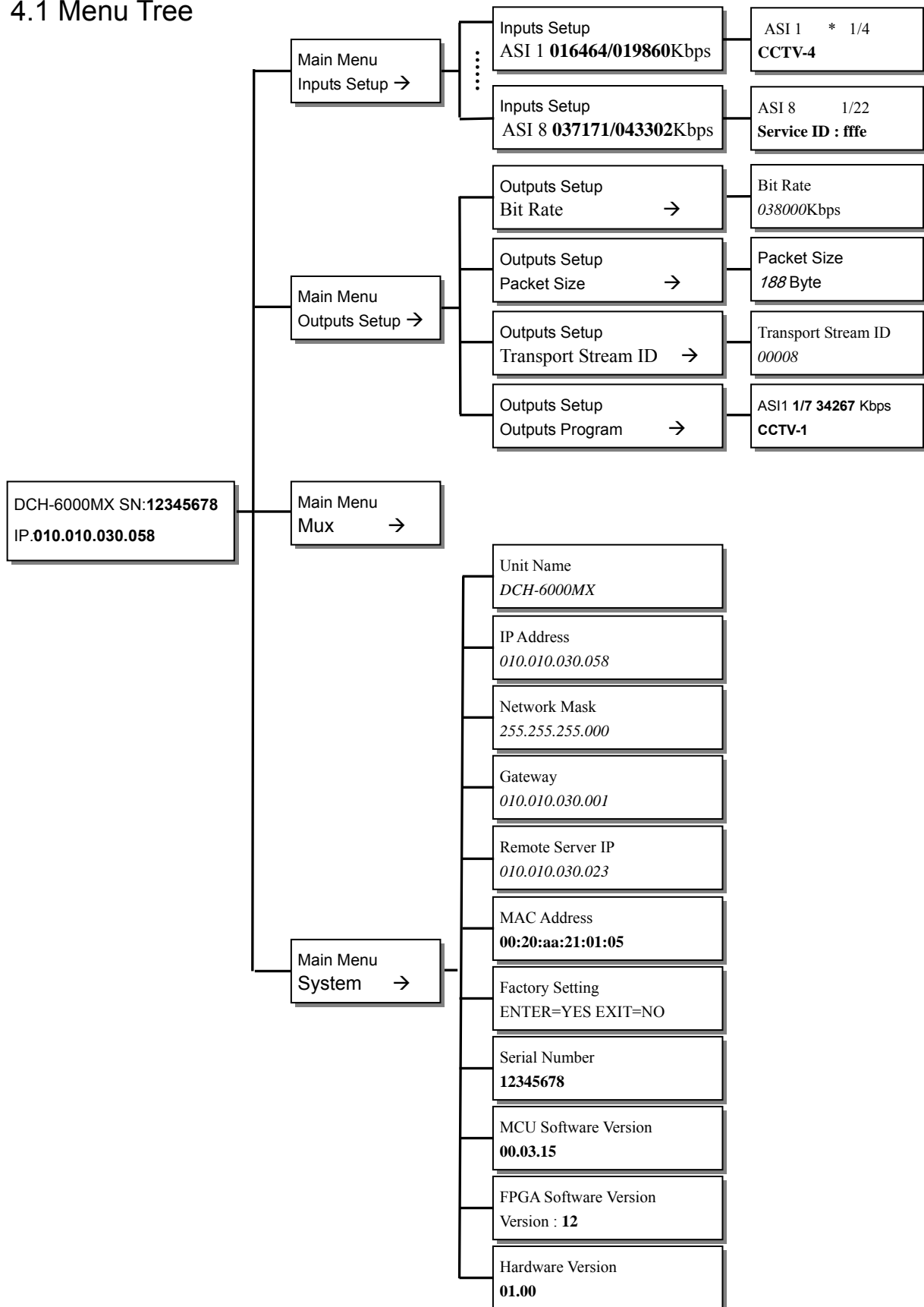

4.2 Menu Operation

4.2.1 Initialization

Connect the DCH-6000MX to an appropriated AC power source, turn on the power switch on the rear panel, the unit will be booted up automatically, and the LCD displays as below

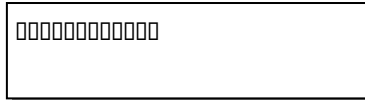

The power on boot up might take several tenths of seconds. The LCD displays as below after initialization:

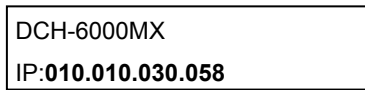

The unit name is displayed on the first row and IP on the second.

Press [ENTER] for entering the main menu then press ▲ or ▼ to navigate through the menu:

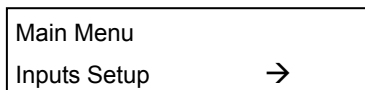

The main menu includes four items

Inputs Setup Configuration of input parameters

Outputs Setup Configuration of output parameters

Muxmux options press [ENTER] to activate

System Configuration of system information

Press or to navigate upward and downward the menu, press ENTER to confirm the selection, press EXIT to exit the menu.

4.2.2 Inputs Setup Menu

Enter Inputs Setup menu the LCD displays as below

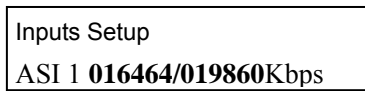

Bit rate of each ASI input port is displayed on the second row, effective TS rate is shown on the left and total TS rate on the right.

Press or to check bit rate among ASI input ports.

Press [ENTER] to check the available services of current ASI input port. An '\$' sign next to the service name indicates the program is being encrypted. Please refer to the diagram below, "1/4", as an example, indicates the service just being shown is the first of all 4 available ones. Press [ENTER] to confirm your selection and an "*" sign indicates this service has just been selected, and will be multiplexed once the multiplexing process is being activated. Press [ENTER] again to de-select the service.

```

ASI 1   *   1/4
CCTV-4

```

Press \leftarrow or \rightarrow to switch channels among ASI ports and press [EXIT] to back to the previous menu. If the any service has been selected, when you back to the main menu, the below message will be displayed on the LCD:

```

Confirm Changed ?
ENTER=YES  EXIT=NO

```

Press [ENTER] to multiplex the selected services and press [EXIT] to discard. If there is no valid ASI input found, if press ENTER and then it displays 'No Program List' as below, then it returns to the previous menu automatically.

```

ASI 1
No Program List

```

4.2.3 Outputs Setup Menu

This menu has 4 items

Bit Rate□ASI output bit rate configuration

Packet Size□packet size setting of ASI output

Transport Stream ID□ID setting of TS multiplexed

Outputs Program□Channel information output

Press \leftarrow or \rightarrow to switch. Press [ENTER] to enter the submenu.

4.2.3.1 Bit Rate

Enter the Bit Rate menu and the LCD displays as below

```

Bit Rate
038000Kbps

```

Output bit rate is from 100kbps to 100000Kbps adjustable. Press \leftarrow or \rightarrow to move the cursor and press \blacktriangle or \blacktriangledown to change the numerical entry(ies). Press [ENTER] to confirm the numerical entry(ies).

Notice: To ensure the sum of all selected services, including some Variable Bit Rate ones, does not exceed the output bit rate actually set, it is recommended to set 1.1 times higher than the static sum of bit rates of all services selected. If the effective output bit rate exceeds the actual setting value, there will be a alarm on the root menu□as below□

```

DCH-6000MX
Outputs 42125Kbps Overflow

```

where 42125Kbps indicates the effective bit rate detected of the Outputs Stream.

4.2.3.2 Packet Size

Packet Size: used for select output packet format as below□

Packet Size 188 Byte

There are 2 kinds of ASI output packet format 188 Bytes and 204 Bytes. Use ▲ or ▼ to switch. Press [ENTER] to select.

Remark: The final effective output Bit rate will be reset, if the packet format is changed.

4.2.3.3 Transport Stream ID

The ID of TS stream is to distinguish from other streams in the same system . Press [ENTER] for entering, as below

Transport Stream ID 00008

The valid range of ID of TS is 065535. Press ◀ or ▶ to move cursor, press ▲ or ▼ to change the digit values and press [ENTER] to select. This example shows an ID number of 8 is set for the final TS multiplexed.

4.2.3.4 Outputs Program

The menu is used for checking the information of the services multiplexed from each input, as below

ASI 1 1/7 34267Kbps
CCTV-1

Port number of input ASI is displayed on the left of the first row. "1/7", as an example, indicates this is the first service from 7 ones on this ASI input, and effective bit rate on the right. Press ▲ or ▼ to check all the services have been multiplexed. The second row is the service name have been multiplexed.

If there is no service being multiplexed, it will display as below

Outputs Setup No Program

4.2.4 Mux Menu

It is used to activate the multiplexing process. When complete the selecting ASI port input programs services from different ASI inputs, and the output parameters settings, press [ENTER], to activate the multiplexing process , the LCD on the front panel will display as below

Start to Mux please wait...

It backs to the main menu, when the process is completed.

4.2.5 System Menu

There are 11 items in the menu as below

Unit Name;

IP Address;

Network Mask;

Gateway;

Remote Server IP;

MAC Address;

Factory Setting;

Serial Number;

MCU Software Version;

FPGA Software Version;

Hardware Version;

Press ▲ or ▼ to switch among these 11 items, and press [EXIT] to back to the previous menu.

4.2.5.1 Unit Name

It is the nicked name of the unit, an example is shown below

Unit Name <i>DCH-6000MX</i>

Press [ENTER] to enter, then press ◀ or ▶ to move the cursor and press ▲ or ▼ to change the character values, press [ENTER] to confirm the value.

4.2.5.2 IP Address

This menu is used for the IP address setting for this DCH-6000MX, this should be an unique address on a LAN network, an example is shown as below

IP Address <i>010.010.030.058</i>

Press [ENTER] to activate, and then press ◀ or ▶ to move the cursor and press ▲ or ▼ to change the digit values, then press [ENTER] to confirm.

4.2.5.3 Network Mask

This menu is used for the network mask setting for the LAN network connected, an example is shown as below

Network Mask <i>255.255.255.000</i>
--

Press [ENTER] to activate, and then press ◀ or ▶ to move the cursor and press ▲ or ▼ to change the digit values, then press [ENTER] to confirm.

4.2.5.4 Gateway

It is used for the gateway setting for the LAN network, an example is shown as below

Gateway 010.010.030.001

Press [ENTER] to activate, and then press ◀ or ▶ to move the cursor and press ▲ or ▼ to change the digit values, then press [ENTER] to confirm.

4.2.5.5 Remote Server IP

It is used for the IP address setting of a computer for network management, this IP address must be the same of the IP address of the computer connected to this DCH-6000MX for remote management, an example is shown as below

Remote Server IP 010.010.030.023

Press [ENTER] to activate, and then press ◀ or ▶ to move the cursor and press ▲ or ▼ to change the digit values, then press [ENTER] to confirm.

4.2.5.6 MAC Address

This menu is used for checking MAC address. MAC address is factory set and every MAC address of all LCT products are unique worldwide. User is not allowed to change the value of MAC address. This sub-menu will show its MAC, and an example is shown below

MAC Address 00:20:aa:21:01:05

4.2.5.7 Factory Setting

This menu is used for recovering factory default settings of this unit as below

Factory Setting ENTER=YES EXIT=NO

Press [ENTER] to select factory setting and [EXIT] to return to the last-level menu.

Notice: When factory setting is selected, all user set parameters will be lost and will be recovered to the factory default ones.

4.2.5.8 Serial Number

This menu is used for serial number checking of this machine, and an example is shown below

Serial Number 12345678

4.2.5.9 MCU Software Version

This menu is used for checking MCU version of this machine, as below

MCU Software Version 00.03.15

4.2.5.10 FPGA Software Version

This menu is used for checking FPGA version of this machine, as below

FPGA Software Version Version : 12
--

4.2.5.11 Hardware Version

This menu is used for checking hardware version of this machine, as below

Hardware Version 01.00

5 Installation and Initial use

User and installer must read this user manual thoroughly and carefully before installation and use.

- Using screw bolts to fix the unit on a 19 inches cabinet.
- Ground the unit on the grounding bolt on the rear panel with appropriated grounding wire to the appropriated grounding terminal(s).
- Connect all input and output connectors to their appropriated sources or destinations.
- Verify the AC electricity source available is within the acceptant range of that of the equipment. Connect the unit to the AC source with power cord originally dispatched, then turn on the power switch near the AC inlet on the rear panel. Please unplug when the unit if not in use for a long period, e.g. 1 week.

For your security, please take attention to the below

Do not use the equipment under strong electric field, strong magnetic field and heat sources temperature range <40 relative humidity<85%

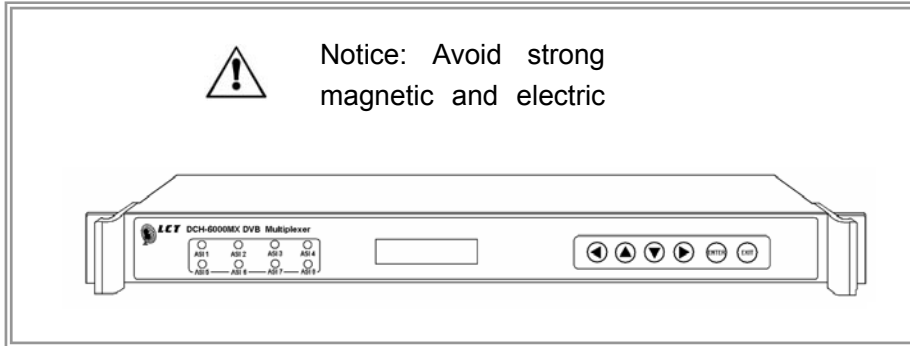

Do not expose the equipment to excessive dust, high humidity nor high temperature
Do not expose the external surface to petrol, thinner or other volatile substances, such as pesticides Use soft cloth to remove dust gently.

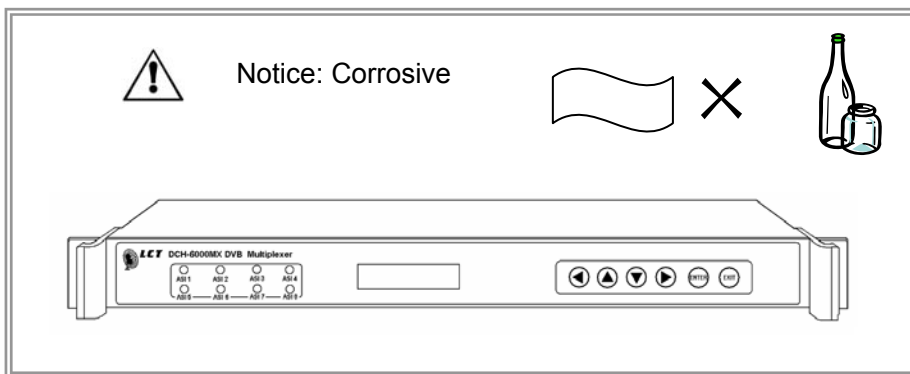

Users are not allowed to remove the top cover of the equipment. If there is any malfunction, please check the connection of the connectors and the power cord on the rear panel. If there is no any improvement, please ask for help from your supplier or service agent.

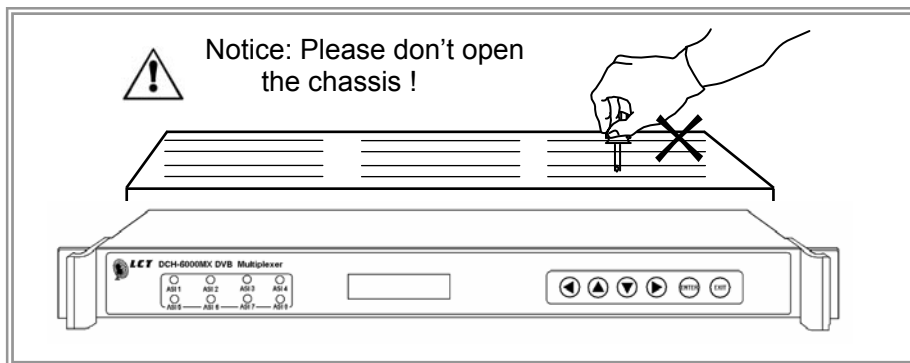

Please connect to an appropriated AC power source which meets the requirement of this unit.

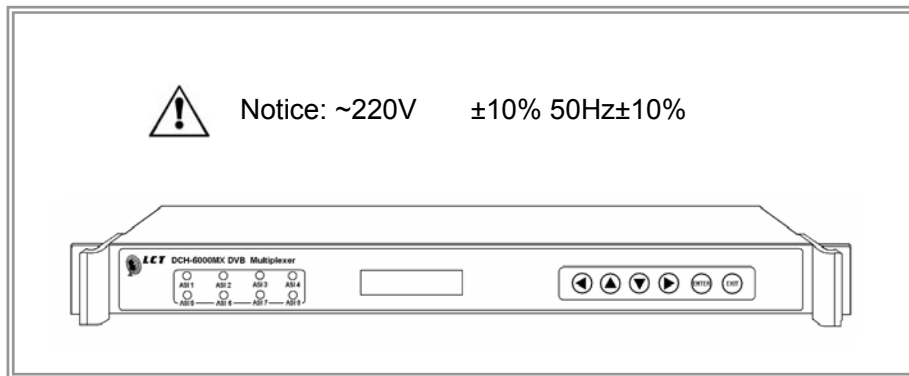

Both this unit and the CATV system connected should be well grounded to an appropriated earth terminal(s).

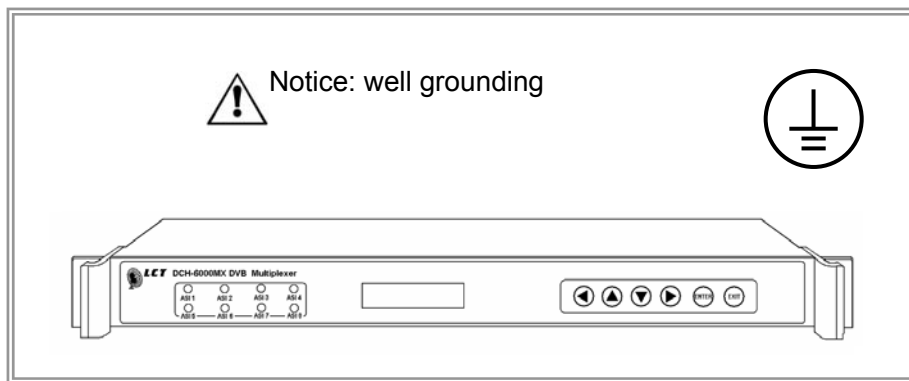

6 Accessories

The following items are dispatched originally with the equipment as the accessory parts:

- a Power cord (might differs from countries),
- a ASI cable,
- an User manual,
- a CD (includes the remote network management software and electronic file of the user manual) ,
- a Quality warrantee card .

